



PORTABLE WIRELESS SPEAKER WITH 3.5MM JACK

MODEL AWS73 INSTALLATION AND OPERATION MANUAL

IMPORTANT INFORMATION

CAUTION

RISK OF ELECTRIC SHOCK.
DO NOT OPEN.

Caution: To reduce the risk of electric shock, do not remove cover (or back). No user serviceable parts inside. Refer servicing to qualified service personnel.

Important Safety Instructions

1. Read these instructions.
2. Keep these instructions.
3. Heed all warnings.
4. Follow all instructions.
5. Clean only with dry cloth.
6. Do not block any ventilation openings. Install in accordance with the manufacturer's instructions.
7. Do not install near any heat sources such as radiators, heat registers, stoves, or other apparatus (including amplifiers) that produce heat.
8. Protect the power cord from being walked on or pinched particularly at plugs, convenience receptacles, and the point where they exit from the apparatus.
9. Unplug this apparatus during lightning storms or when unused for long periods of time.
10. Refer all servicing to qualified service personnel. Servicing is required when the apparatus has been damaged in any way, such as power-supply cord or plug is damaged, liquid has been spilled or objects have fallen into the apparatus, the apparatus has been exposed to rain or moisture, does not operate normally, or has been dropped.

For PLUGGABLE EQUIPMENT, the socket-outlet shall be installed near the equipment and shall be easily accessible.

The apparatus shall not be exposed to dripping or splashing or placed near objects filled with liquids.

Care and Maintenance

- Always use a soft cloth to clean the speaker and transmitter. Never use any product containing alcohol or other solvents as they may damage the surface.
- Use caution when plugging the power transformers in an AC outlet to avoid the risk of electric shock.
- If the speaker are used outside on a deck or patio, make sure you take them indoors in the event of a rainstorm to prevent possible damage.
- Do not operate or store the system in extreme temperatures (below 32°F/0°C and above 122°F/50°C).

Product Information

Keep your sales receipt to obtain warranty parts and service and for proof of purchase. Attach it here and record the serial and model numbers in case you need them. These numbers are located on the product.

Model No.: _____

Purchase Date: _____

Dealer/Address/Phone: _____

INTRODUCTION

The Acoustic Research Portable Wireless Speaker with 3.5mm jack lets you enjoy your music anywhere, at home or on the go, with two ways to connect to your music. The 900MHz wireless transmitter gives you 150ft* of room to roam from your audio source, great for outdoor entertaining at home, with crystal-clear wireless audio. The speaker's 3.5mm jack offers a convenient connection option to use anywhere you go—just connect your MP3 player or smartphone to the speaker, and enjoy!

This manual covers various connection options and detailed operating instructions for making the AR Wireless Speaker System a valued part of your lifestyle. If, after having reviewed the instructions, you have any questions, please call toll-free 1-800-732-6866 or visit www.acoustic-research.com.

**Range may vary according to environment.*

TOUR OF THE SPEAKER

Speaker

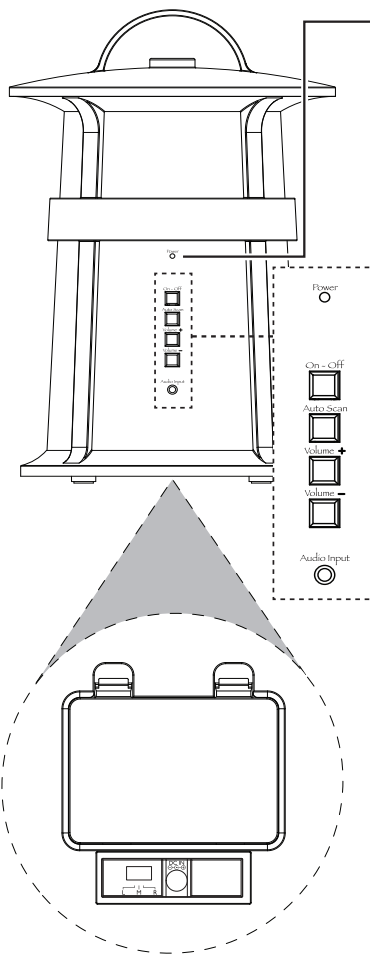

Back panel

Power indicator blinks when the speaker is first powered on; it turns solid blue when the speaker is tuned to the transmitter.

On-Off button turns the speaker on and off.

Auto Scan button rescans for the transmitter's signal.

Volume +/- buttons adjust the speaker's volume level.

Audio Input connects directly to your MP3 player, smartphone, or other portable audio device, using the 3.5mm audio in cable provided.

Bottom Panel

L/M/R switch determines if the speaker plays sound in mono as a stand-alone speaker, or plays the left or right track in a stereo pair with an additional AWS73.

DC IN receives the small round end of the included 10V 1500mA AC power adapter; remove the protective cover to insert the adapter.

Battery Compartment Cover (not shown) remove to install 6 AA batteries.

TOUR OF THE SPEAKER

900MHz Wireless Transmitter

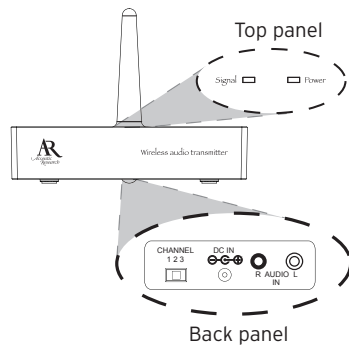

SIGNAL indicator lights green when the audio is present and the transmitter is broadcasting.

POWER indicator lights when the transmitter is on.

CHANNEL 1 2 3 lets you find the best transmission frequency for your environment.

DC IN jack receives the small round end of the included 12V 200mA AC power adapter.

AUDIO IN (R / L) connects to your sound source using one of the connection options shown here.

Included Accessories

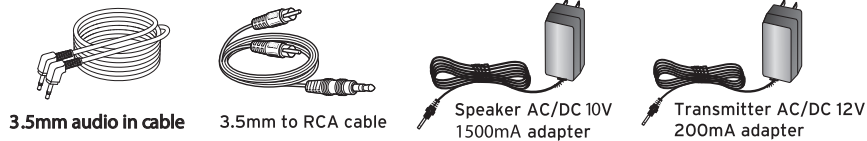

Note: These power units should be plugged in so that they stay vertical or lie flat.

POWERING THE SPEAKER SYSTEM

Powering the Transmitter

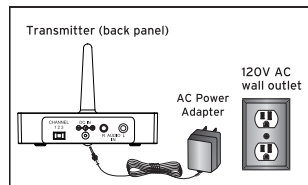

Connect the small, round plug from the transmitter AC power adapter to the transmitter's DC IN jack. Plug the other end of the transmitter AC power adapter into any standard 120V AC wall outlet.

Note: Be sure to use the speaker AC power adapter rated 12V DC 200 mA (it has the smaller diameter plug).

Note: There is no transmitter ON/OFF switch. The transmitter is designed to be left plugged in and powered at all times. If you will not be using the AWS73 for an extended period of time, unplug the transmitter AC power adapter.

Powering the Speaker

There are two options to power your wireless speaker: using the included AC power adapter or using 6 AA batteries (not included).

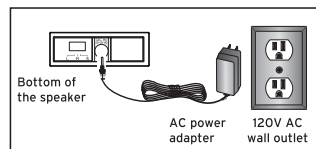

AC Power Adapters

1. Insert the small, round plug from the speaker AC power adapter into the DC IN jack on the bottom of the speaker.
2. Plug the other end of the speaker AC power adapter into any standard 120V AC wall outlet.

Note: Be sure to use the speaker AC power adapter rated 10V DC 1500 mA.

Warning: This product is water-resistant, not waterproof. Avoid prolonged exposure to wet environments, such as rain, mist, dew, etc. In other words, you can take it out, just don't leave it out. If you plan to use the speaker in a humid or wet environment, we recommend powering it with batteries instead of with the power adapter.

POWERING THE SPEAKER SYSTEM

AA Batteries

1. Remove the battery compartment cover on the bottom of the speaker.
2. Insert six (6) AA batteries (not included) into the speaker following the polarity (“+” and “-”) as diagrammed inside the battery compartment.
3. Replace the battery compartment cover on the bottom of the speaker.

Note: Place the rubber cap in the speaker power input jack when using batteries.

DO NOT mix batteries with different chemistry types (for example, a zinc battery with an alkaline battery). **DO NOT** mix new and used batteries. **DO NOT** leave batteries installed in the product when not in use for long periods. Always remove old, weak or worn-out batteries promptly and recycle or dispose of them in accordance with local and national regulations.

SETTING UP FOR WIRELESS AUDIO

Connecting to an Audio Source

Connecting to an A/V Receiver

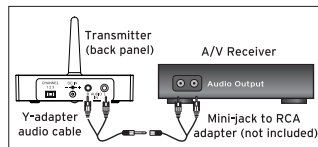

1. Plug the stereo plugs on the provided Y-adapter audio cable into the AUDIO IN jacks on the back of the transmitter (make sure to match the colors on the plugs and jacks).
2. Plug the mini-plug end of the provided Y-adapter into a mini-jack to RCA adapter (not included).
3. Connect the stereo plugs on the mini-jack to RCA adapter to the corresponding left and right audio outputs of your A/V receiver, amp, or other audio source.

Connecting to a Portable Audio Device

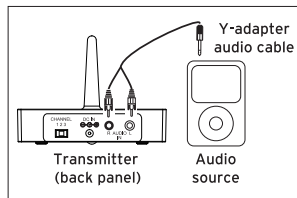

1. Plug the stereo plugs on the provided Y-adapter audio cable into the AUDIO IN jacks on the back of the transmitter.
2. Plug the mini-plug end of the provided Y-adapter into the headphone output of your MP3 player or other portable audio device.

Adjusting the Transmitter

1. Turn on your audio source (for example, A/V receiver, MP3 player, stereo, etc.) and play music at a normal listening volume.

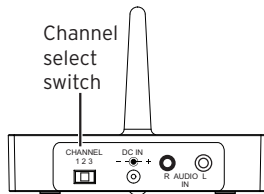

2. Set the channel select switch on the back of the transmitter to one of the transmitter's three broadcast frequencies: 1, 2 or 3. If you experience poor reception or interference, try choosing a different frequency by moving the channel select switch to another position.

When the transmitter is receiving an audio signal and is ready, the SIGNAL indicator turns solid green.

Note

If the SIGNAL indicator on the transmitter does not turn on, please check the following:

- Confirm the transmitter AC power adapter is securely connected.
- Confirm the cable from the transmitter is securely connected to the audio source output (MP3 player, A/V receiver, etc.).
- Confirm the audio source is playing audio and is turned up.

Streaming Audio with the 900MHz Wireless Transmitter

1. Make sure the 900MHz transmitter is on and that there's something playing on your audio source. Turn your audio source up to at least 3/4 full volume.
2. If the speaker isn't already on, press the On-Off button to turn it on.
3. The indicator light starts flashing, which means the speaker is trying to link with the 900MHz wireless transmitter. The indicator light turns solid blue when the speaker is tuned to the 900MHz wireless transmitter—you should hear sound coming from the speaker now.

Note: If the speaker is not linked to the 900MHz transmitter, or if the transmitter isn't connected properly, the indicator light will continue to blink. If this occurs, please see the Troubleshooting section of this manual.

IMPORTANT: The indicator light on the back of the speaker indicates the status of the wireless connection only. If you're not using the transmitter (or if you're out of range of the transmitter) it will keep blinking until it finds the transmitter. This is normal.

4. Adjust the volume on the speaker as desired.

Notes: If you're using a single speaker with this transmitter, keep the L/M/R switch on the bottom of the speaker in the "M" position (for mono). If you're using more than one speaker with this transmitter, set the speakers to the "L" (left) or "R" (right) positions according to their orientation to the listener.

The speaker automatically retunes if it loses the transmitter's signal. You can also press the AutoScan button on the back of the speaker to retune the speaker at any time.

The transmitter turns off automatically if there is no audio signal present for a prolonged period.

Interference in the form of static and/or distortion can sometimes be heard. If this occurs, confirm the transmitter/speaker adjustments and indicators. If the problem persists, refer to the Troubleshooting section of this manual.

USING THE AUXILIARY AUDIO INPUT

Making a Direct Connection

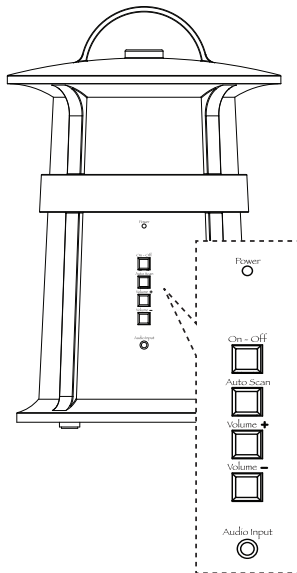

1. Connect one end of the provided 3.5mm audio in cable to the AUDIO IN jack on the back of the speaker.
2. Connect the other end of the cable to the headphone output on your MP3 player or other portable audio device.
3. If the speaker isn't already on, press the On-Off button to turn it on.

Warning: This product is designed to work with line level outputs or headphone outputs only. **DO NOT** connect it directly to speaker outputs as it will permanently damage the speaker.

TURNING THE SPEAKER OFF

1. Press the On-Off button on the back of the speaker to turn the speaker off.
2. Confirm that the speaker is off by verifying that the indicator light on the speaker's back panel is no longer illuminated.

TROUBLESHOOTING

The following troubleshooting guide takes you through some of the more common problems associated with the installation and/or operation of a wireless system. If the problem persists, please call toll-free at 1-800-732-6866 or visit www.acoustic-research.com.

Issue:	Cause and solution:
No sound	<ul style="list-style-type: none">• Check that the transmitter AC power adapter is fully inserted into the wall outlet and the power cord from the AC adapter is firmly connected to the transmitter power input jack.• Confirm that the speaker is turned on and tuned to the transmitter—the indicator light on the back of the speaker should be solid blue (not blinking).• If you're using the power adapters, confirm that both (for the speaker and for the transmitter) are fully inserted into their wall outlets and the adapter power cords are firmly connected to the power input jacks on the transmitter or speaker. <p>or</p> <ul style="list-style-type: none">• If you're using batteries for the speaker, check that they are fresh and inserted with correct polarity (+, -).• Check that the audio source component (stereo, MP3 player, etc.) is turned on and transmitting sound as it normally should.• Make sure the volume on your audio source is turned up.• Check that the speaker volume is turned up.• If you are using a Tape 2 Monitor output from your receiver/amp as the audio output, check that you have pressed the Tape Monitor/Tape 2 button on the front of the receiver. This will turn on the Tape 2 outputs, which may not have been active.
Issue:	Cause and solution:
Sound is distorted or has static	<ul style="list-style-type: none">• When using battery power, make sure the batteries are fresh and replace if necessary.• Check that the speaker's indicator light is solid blue (not blinking) when an audio source is connected to the transmitter• Change the position of the channel select switch (1, 2 or 3) to change the operating frequency. Then press the AutoScan button on the speaker's back panel to make the speaker retune.• Change the location of the transmitter. Place it as high and away from obstructions as possible. Avoid placing the transmitter directly on top of or behind a TV.• Move the transmitter and speaker closer together. Sending the signal through certain materials, such as glass, tile, and metal, can decrease the effective transmitting distance of the system.

SPECIFICATIONS

Transmitter

- *Omni-directional 900MHz broadcast*
- *Effective transmitting range: up to 150 ft. (45m)**
- *Phase-locked loop circuitry (PLL)*
- *3 selectable broadcast frequencies*
- *Stereo audio input*

**Maximum range; results may vary according to environment.*

Speaker

- Push-button, auto-lock tuning
- 2-way acoustic design:
 - 2" tweeter, 3" woofer
- 10 Watt rated internal amplifier
- Omni-directional receiver
- Frequency response: 40Hz - 15kHz
- Left/Mono/Right switch
- Operates using supplied AC adapter or six (6) AA batteries (not included)

FCC Statement

This device complies with Part 15 of the FCC Rules. Operation is subject to the following two conditions:

1) This device may not cause harmful interference, and 2) This device must accept any interference received, including interference that may cause undesired operation.

This equipment has been tested and found to comply with the limits for a Class B Digital Device, pursuant to Part 15 of the FCC Rules. These limits are designed to this equipment generates, uses, and can radiate radio frequency energy and, if not installed and used in accordance with the instructions, may cause harmful interference to radio communications. However, there is no guarantee that interference will not occur in a particular installation. If this equipment does cause harmful interference to radio or television reception, which can be determined by turning the radio or television off and on, the user is encouraged to try to correct interference by one or more of the following measures:

- Reorient or relocate the receiving antenna.
- Increase the separation between the equipment and receiver.
- Connect the equipment into an outlet on another circuit.
- Consult the dealer or an experienced radio/TV technician for help.

Caution: Any changes or modifications not expressly approved by the party responsible for compliance could void the user's authority to operate this equipment.

Industry Canada Regulatory Information

This device complies with RSS-210 of the Industry Canada Rules. Operation is subject to the following two conditions: 1) this device may not cause interference and 2) this device must accept any interference, including interference that may cause undesired operation of the device.

This class B digital apparatus complies with Canadian ICES-003.

IC Radiation Exposure Statement: This equipment complies with IC radiation exposure limits set forth for an uncontrolled environment.

Avis d'Industrie Canada

Cet appareil est conforme à la norme CNR-210 des règlements d'Industrie Canada. Son fonctionnement est sujet aux deux conditions suivantes: 1) Cet appareil ne doit pas provoquer d'interférences et 2) Cet appareil doit accepter toutes les interférences, y compris celles pouvant entraîner son dysfonctionnement.

Cet appareil numérique de la classe B est conforme à la norme NMB-003 du Canada

Avis d'Industrie Canada sur l'exposition aux Rayonnements: Cet appareil est conforme aux limites d'exposition aux rayonnements d'Industrie Canada pour un environnement non contrôlé.

RF Exposure Warning

This equipment must be installed and operated in accordance with provided instructions and the antenna(s) used for this transmitter must be installed to provide a separation distance of at least 20 cm from all persons and must not be co-located or operating in conjunction with any other antenna or transmitter. End-users and installers must be provide with antenna installation instructions and transmitter operating conditions for satisfying RF exposure compliance.

12 MONTH LIMITED WARRANTY

VOXX Accessories Corporation (the "Company") warrants to the original retail purchaser of this product that should this product or any part thereof, under normal use and conditions, be proven defective in material or workmanship within 12 months from the date of original purchase, such defect(s) will be repaired or replaced (at the Company's option) without charge for parts and repair labor. To obtain repair or replacement within the terms of this Warranty, the product along with any accessories included in the original packaging is to be delivered with proof of warranty coverage (e.g. dated bill of sale), specification of defect(s), transportation prepaid, to the Company at the address shown below. Do not return this product to the Retailer.

This Warranty is not transferable and does not cover product purchased, serviced or used outside the United States or Canada. The warranty does not extend to the elimination of externally generated static or noise, to costs incurred for the installation, removal or reinstallation of the product.

The warranty does not apply to any product or part thereof which, in the opinion of the company, has suffered or been damaged through alteration, improper installation, mishandling, misuse, neglect, accident or exposure to moisture. This warranty does not apply to damage caused by an AC adapter not provided with the product, or by leaving non-rechargeable batteries in the product while plugged into an AC outlet.

THE EXTENT OF THE COMPANY'S LIABILITY UNDER THIS WARRANTY IS LIMITED TO THE REPAIR OR REPLACEMENT PROVIDED ABOVE AND, IN NO EVENT, SHALL THE COMPANY'S LIABILITY EXCEED THE PURCHASE PRICE PAID BY PURCHASER FOR THE PRODUCT.

This Warranty is in lieu of all other express warranties or liabilities. ANY IMPLIED WARRANTIES, INCLUDING ANY IMPLIED WARRANTY OF MERCHANTABILITY OR FITNESS FOR A PARTICULAR PURPOSE, SHALL BE LIMITED TO DURATION OF THIS WARRANTY. ANY ACTION FOR BREACH OF ANY WARRANTY HEREUNDER, INCLUDING ANY IMPLIED WARRANTY, MUST BE BROUGHT WITHIN A PERIOD OF 24 MONTHS FROM THE DATE OF ORIGINAL PURCHASE. IN NO CASE SHALL THE COMPANY BE LIABLE FOR ANY CONSEQUENTIAL OR INCIDENTAL DAMAGES WHATSOEVER. No person or representative is authorized to assume for the Company any liability other than expressed herein in connection with the sale of this product.

Some states/provinces do not allow limitations on how long an implied warranty lasts or the exclusion or limitation of incidental or consequential damage so the above limitations or exclusions may not apply to you. This Warranty gives you specific legal rights and you may also have other rights which vary from state/province to state/province.

U.S.A.: Audiovox Return Center, 150 Marcus Blvd., Hauppauge, New York 11788

CANADA: Audiovox Return Center, c/o Genco, 6685 Kennedy Road, Unit #3 Door 16, Mississauga Ontario L5T 3A5