

1 Welcome

Thanks for choosing the Ninebot Gokart Kit, hereinafter referred to as the Gokart Kit.

The Gokart Kit is an accessory developed specifically for the Ninebot by Segway products listed below. When the Gokart Kit is attached to the appropriate Ninebot by Segway product it becomes an electric Gokart. You must read and follow these instructions as well as the instructions provided with the applicable Ninebot by Segway product.

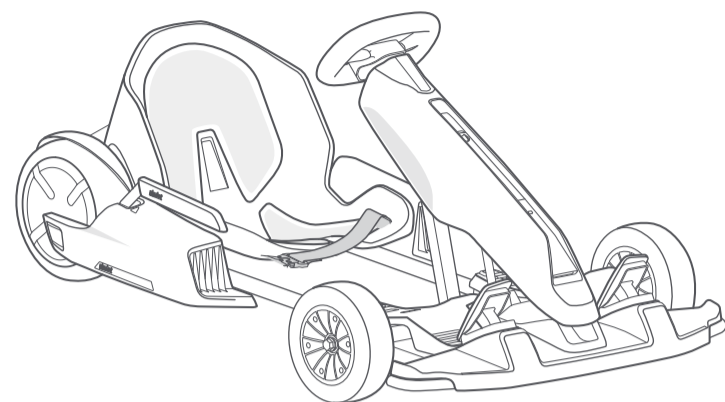

- The Gokart Kit is only suitable for use with the Ninebot by Segway miniPRO (Model: N3M260, N3M320). (hereinafter collectively referred to as the miniPRO)
- Segway miniPLUS, Segway miniLITE, and other similar shaped products cannot be used with the Gokart Kit.

⚠ WARNINGS

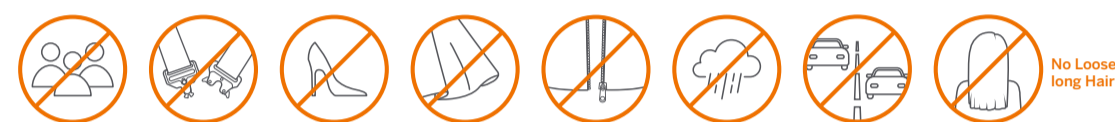

- To reduce the risk of injury, adult supervision is required. Never use in roadways, near motor vehicles, on or near steep inclines or steps, swimming pools or other bodies of water; always wear shoes, and never allow more than one rider.
- Always fasten seat belt, wear a helmet with long hair tucked inside and wear protective gear. Loose clothing or hair can become stuck in wheels or block your vision. Wear appropriate closed toed, secure footwear. No loose clothing.
- Do not drive in rain or snow. When not in use, park the Gokart indoors to avoid water entering and damaging the vehicle.
- Comply with all local laws and regulations.

⚠ Risk of death or serious injury from collisions and falls. To reduce the risk of injury user and/or adult must read and follow the user manual.

Correct dress code

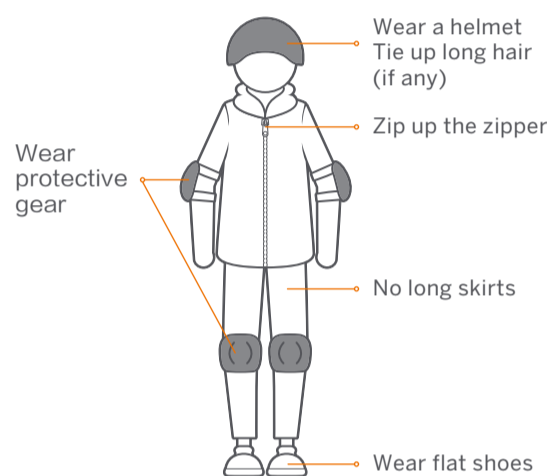

corrected. Contact after-sales service for assistance.

Who Should Drive:

The manufacturer recommends drivers be at least 8 years old. Children under the age of 16 should only drive under adult supervision. Always follow these safety instructions:

- A. People who should not drive the Gokart include:
- Anyone under the influence of alcohol, drugs, or intoxicants.
 - Anyone who suffers from disease that puts himself/herself at risk if he/she engages in strenuous physical activity.
 - Anyone whose weight is outside the stated limits (see Specifications).
 - Pregnant women.
- B. The Gokart is intended for one person only.
- C. To drive safely, you must be able to clearly see what is in front of you and you must be clearly visible to others.
- D. Drivers must be able to hear the environment around them.

After Each Drive:

1. Park the Gokart on flat ground and power it off. Failure to do so could cause the Gokart to move when exiting potentially causing injury to you and others around you.
2. Allow the Gokart to cool down before charging. Do not attempt to charge the Gokart, if it, the charger, or the power outlet is wet. Follow instructions in the miniPRO User Manual.
3. As with any electronic device, use a surge protector when charging to help protect your Gokart from damage due to power surges and voltage spikes.
4. Only use the charger specified by the manufacturer. Do not use a charger from any other product.
5. Only use Ninebot or Segway approved parts and accessories. Do not modify your Gokart. Modifications to your Gokart could interfere with the operation and performance of the Gokart, which may result in serious injury and/or damage, and could void the Limited Warranty.

Maintenance and Storage:

1. Be sure the Gokart is powered off before performing any maintenance or when installing or replacing parts.
2. When installing components, use proper and sufficient force until the component is secure. If the installation is too loose or too tight, the Gokart may not function properly resulting in the potential for injury to you or others or damage to, or malfunction of, the Gokart.
3. Install batteries for the Gokart in accordance with the instructions and ensure that the positive and negative electrodes of the batteries are installed correctly. Only use the batteries specified by the manufacturer. Do not charge the batteries as this may cause a risk of fire or explosion. Do not mix old and new batteries. Do not mix alkaline, standard (carbon-zinc), or rechargeable batteries. When the batteries are dead, purchase and replace them yourself.

4. Follow all instructions contained in the miniPRO User Manual when performing maintenance on the miniPRO.
5. Do not use a strong water flow or high-pressure hoses to clean the Gokart. Avoid getting water in the charge port. If your Gokart has been exposed to heavy rain store it outdoors away from buildings and people but protected from the elements until it is dry.
6. Store your Gokart indoors. The miniPRO should be stored in an environment where the temperature is no higher than 122°F (50°C) or lower than -4°F (-20°C). If the temperature of the storage environment is lower than 32°F (0°C), do not charge it until after placing it in a warm environment (over 50°F (10°C)).

The data and parameters of the Ninebot Gokart vary with different models. They are subject to change without prior notice. Go to www.segway.com for updated information.

2 Riding Safety

1. The Gokart is a recreational product. Before mastering riding skills, you need to practice. Neither Ninebot (Ninebot (Beijing) Tech Co., Ltd. or its subsidiaries and affiliates) nor Segway Inc. is responsible for injuries or damage caused by a driver's inexperience or failure to follow the instructions in this User Manual or in the New Rider Tutorial.
2. Remember as with any mode of transportation, that whenever you drive the Gokart, you risk injury or death from loss of control, collisions, and falls. You can reduce the risk by following all the instructions and warnings in this manual, but you cannot eliminate all the risks.
3. The Gokart kit contains small parts which can create a choking hazard. Keep small children away from the Gokart.

Pre-Ride Checklist and Preparing for Your Drive:

1. Before each drive check and tighten any loose parts, fasteners, straps, and replace damaged components.
2. To avoid accidents caused by improperly inflated or worn tires, check the tire pressure on the miniPRO tires and wear on all tires before each ride. Do not touch moving or spinning tires.
3. Ensure that the battery level and vehicle operating status are within the specifications contained in the manual of the model being used with the Gokart Kit.
4. Carefully read, understand and follow all instructions in this User Manual and watch and understand the New Rider Tutorial in the App before your first drive. Do not attempt to drive the Gokart if you are not able to drive in accordance with the instructions in this Manual or you risk serious injury or death.
5. Always wear appropriate shoes, clothing, and protective gear when riding. Protective gear includes the use of a helmet, knee pads, and elbow pads (not included). Use an approved bicycle or skateboard helmet that fits properly with the chin strap in place, and provides protection for the back of your head. Remove or tie back anything loose (i.e. clothing, hair, jewelry, etc.) that could be caught in any moving parts. Always fasten the seat belt before riding and ensure it is securely tightened. Loose seat belt can get stuck in the wheels.
6. Do not turn the Gokart on unless it is parked on flat ground.

Where to Drive:

1. When entering public spaces, always comply with the local laws and regulations. Only ride in areas where you have first obtained permission from the property owner.
2. The Gokart is designed to be driven on a dry, flat, hard-surface, free of obstacles, bumps, holes, and other hazards.
3. The kinds of surfaces which are appropriate for safe use of the toy.
4. Do not drive on roadways, near motor vehicles, pedestrians, bicyclists, animals, on or near steep inclines or steps, curbs, near swimming pools, through puddles or other bodies of water. Use caution when riding in areas with trees, posts, or fences. You must leave sufficient space between you and those

- items to be able to safely pass them.
5. The Gokart is never to be ridden indoors.
6. Do not ride the Gokart at night.
7. Do not ride on any ramp or incline that exceeds the maximum slope.
8. Do not ride in the snow, rain, or on roads which are wet, muddy, icy, or that are slippery for any reason. Do not ride over obstacles (including, but not limited to, sand, loose gravel, or sticks). Doing so could result in a loss of balance or traction and could cause a collision.
9. Do not allow the Gokart to get wet. You risk damage to the batteries and potential for a fire or explosion due to a wet battery pack.

How to Drive:

1. As with other vehicles, faster speeds require longer braking distance. Sudden acceleration or braking on smooth surfaces could lead to wheel slip and collisions.
2. Be cautious and always keep a safe distance between you and others when driving. Be alert and slow down when entering unfamiliar areas.
3. Do not allow anyone to drive your Gokart on his/her own unless he/she has carefully read this manual, and followed the New Rider Tutorial. The safety of new riders is your responsibility. Assist new riders until they are comfortable with the basic operation of the Gokart and make sure each new rider wears a helmet and other protective gear.
4. To avoid distraction when driving your Gokart, do not use a cell phone, camera, headphones, ear buds or perform any other activities while driving.
5. Be alert! Scan both far ahead and in front of you. Your eyes are your best tool for safely avoiding obstacles and low traction surfaces (including, but not limited to, wet ground, loose sand, loose gravel, and ice). Use caution when transitioning over differing terrain.
6. When approaching or crossing an intersection, road, corner, or gate of any kind, always slow down and yield to others.
7. Do not drive at unsafe speeds. You must always use good judgment based on your driving skills and the surrounding environment.
8. Always slow down when turning. Turning at a high speed can cause loss of control, possible vehicle turn-over, and risk of injury or death.
9. Do not perform stunts of any kind. All four tires must remain on the ground at all times.
10. While driving the Gokart, always remain seated with arms and legs inside the Gokart.
11. Do not carry cargo of any kind.
12. If the Gokart makes an abnormal sound or signals an alarm while driving, stop immediately and do not use the Gokart or miniPRO until the cause of the noise/alarm has been identified and

3 Packing List & Diagram

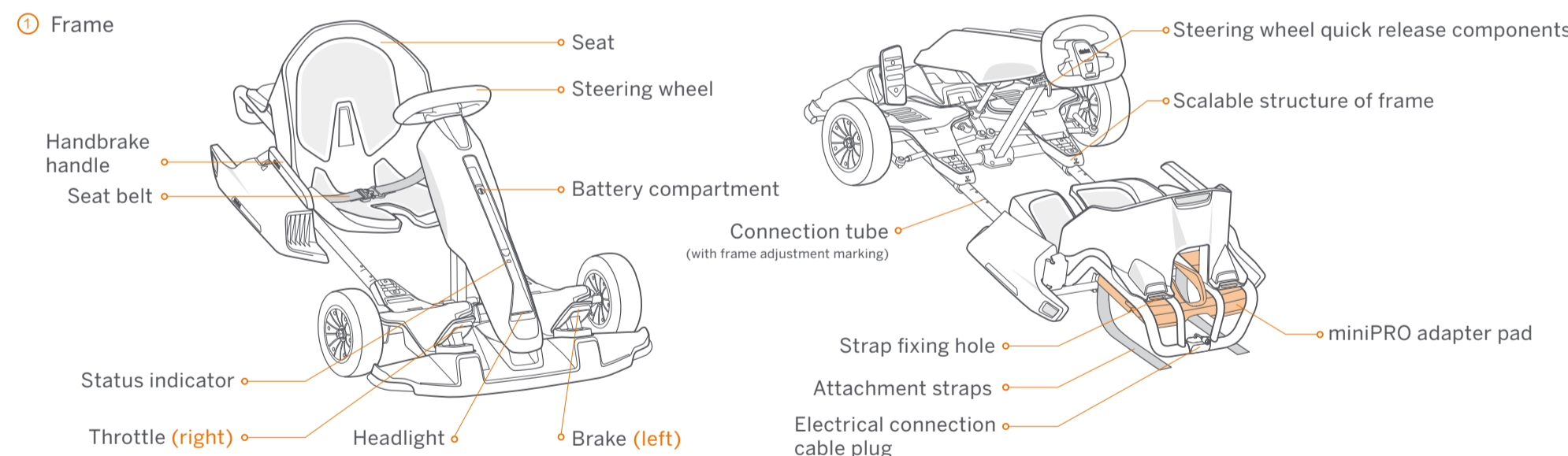

- ② User Manual & Limited Warranty
- ③ miniPRO Adapter Pad
- ④ Hex Wrenches
- ⑤ 6 (AA) Batteries

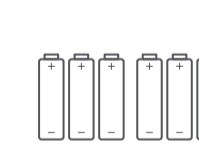
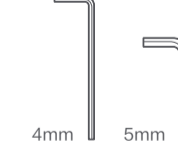
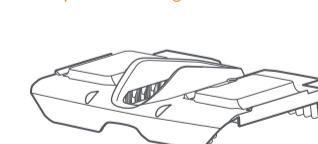

- ⑥ Tools provided to remove the steering bar bracket

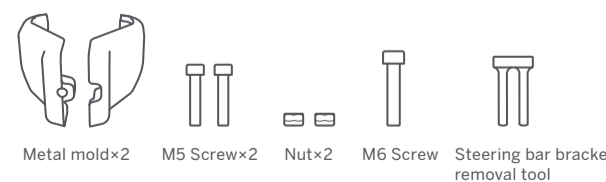

- ⑦ Steering wheel quick release components



- ⑧ Power extension cord

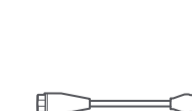

To use the Gokart Kit the following accessory must be purchased separately. It can be purchased at www.segway.com

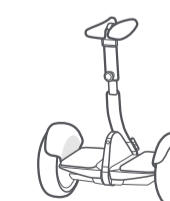

miniPRO

⚠ When unpacking your Gokart, please verify that the above items are included in the package. If you are missing any components, please contact your dealer/distributor or nearest service center (see Contact). Please retain the box and packaging materials in case you need to ship your Gokart in the future. Always power off your Gokart and unplug the power source before cleaning.

4 Assembling your Gokart (Requires two adults to assemble)

Operating the miniPRO

⚠ The Gokart is assembled by attaching the Gokart Kit to a miniPRO. Before assembly of the Gokart, please review the miniPRO User Manual and follow all instructions contained in it. Once the miniPRO has been properly activated and charged you can begin assembly of the Gokart.

① Update the miniPRO firmware

➤ Install the app

Download the Segway-Ninebot app (hereinafter referred to as the app) by any of the following methods:

- Scan the QR code below
- Download in Google Play Store or Apple's App Store



Segway-Ninebot App



* Your mobile phone requires Bluetooth 4.0 or later, iOS system 8.0 or later, or Android™ 4.3 or later.

➤ Pair your mobile phone and the miniPRO

- Turn on the phone's Bluetooth.
- Press the power button to turn on the miniPRO.
- Open the app to search for and connect your miniPRO.

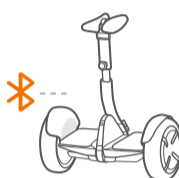

➤ Update firmware and switch modes

- In the upper right corner of the app, tap Settings → Firmware Update.
- On the Ninebot settings page, tap "Gokart mode".
- Enable "Gokart mode".



* This firmware update does not involve activation of the miniPRO. If you need to use the miniPRO, please refer to the miniPRO User Manual for related operations.

② Remove the steering bar from the miniPRO

Scan the QR code on the right to review Assembly Instructions.



Assembly Instructions

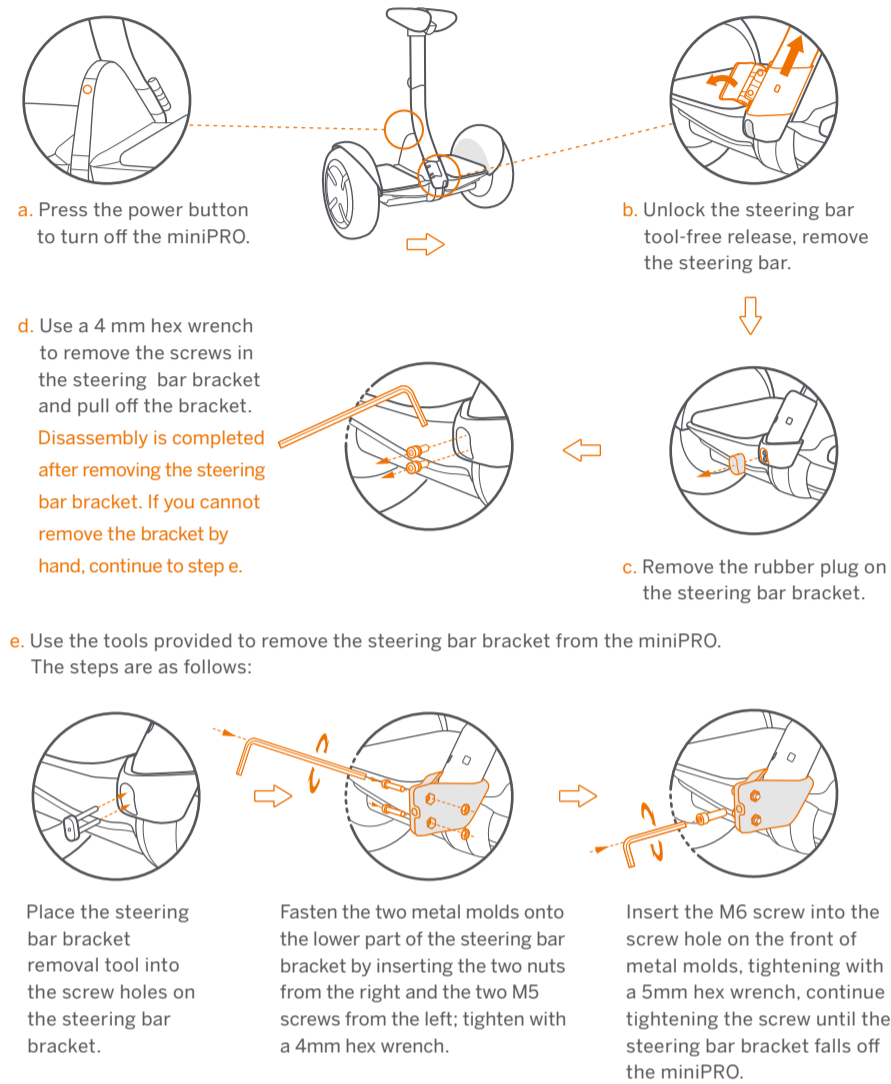

③ Check the status of the miniPRO

Refer to the chapter "Maintenance" in the miniPRO User Manual to ensure that the tire performance, the battery level, and the running status of the miniPRO are normal.

Assembling and disassembling the Gokart

⚠ This assembly is for adults only. Do not power on the miniPRO during assembly or disassembly.

⚠ Before assembly, update the app's firmware and turn on Gokart mode.

➤ Assembly

① Plug the power extension cord into the charging port of the miniPRO, tighten by turning clockwise.

② Install the miniPRO adapter pad. Located under the frame. Remove the attachment strap before removing from the frame.

③ Place the Gokart frame on the miniPRO.

④ Pass the attachment straps through the bottom of the miniPRO and the strap fixing holes. Tighten the straps. **⚠** Make sure the safety straps are secured to prevent accidental release.

⑤ Once fully assembled, make sure:

- The miniPRO adapter pad and the miniPRO are facing the correct direction.
- The attachment straps are properly attached and tightened.
- The electrical connection cable is plugged into the power extension cord.
- The body length and steering wheel height is appropriate for the rider.
- The battery compartment is closed. If anything appears to be incorrect, stop using the Gokart and contact after-sales service.

⑥ Install the Gokart batteries.

Unscrew the battery compartment cover and insert batteries into the compartment. Close and tighten the cover. **⚠** To avoid issues that may be caused by corrosion, remove the batteries if not using the Gokart for an extended period of time.

⑦ Adjust the steering wheel height:

- a Raise the steering wheel to a suitable height.
- b Insert the quick release screw into the hole of the corresponding height.
- c Tighten the quick release nut.
- d Press to fix the steering wheel quick release components.
- e Ensure the steering wheel does not shake. Otherwise, repeat the steps b, c, d, e.

⑧ Stretch the frame and adjust the length of the body:

- a With both hands holding the steering wheel and the seat, stretch the frame out to a suitable position along the horizontal direction of the connection tube.
- b Align the scalable structure of the frame with the marking on the connection tube.
- c Positioning: Use a 5mm hex wrench to press the two screws into the holes on the left and right connection tube in order, as shown in the figure above (The screw is set to a depth of about 1cm for successful position).
- d Tighten the 4 screws.

➤ Disassembly

➤ Press the miniPRO's power button to turn off the Gokart.

➤ Disconnect the electrical connection cable.

➤ Refer to the assembly procedure and carry it out in reverse order.

5 Driving the Gokart

Activate the Gokart

➤ Press the power button on the miniPRO to turn on the Gokart. The Gokart will automatically power off when idle for 10 minutes.



➤ Open the Segway-Ninebot APP and connect your Gokart.

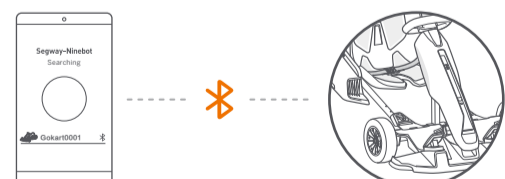

➤ Follow the instructions in the app to activate the Gokart and complete the corresponding tutorial and exercises.

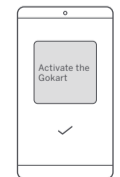

⚠ For your safety, the default values of the Gokart speed and sensitivity are set to low. Use the app to learn how to drive safely, then the speed limit can be gradually raised.

Use and charging

① Fastening the seat belt
Sitting on the seat, buckle the left and right parts of the seat belt in front of you.

② Driving
Acceleration: lightly press the throttle (right pedal) to go forward.
Deceleration: lightly press the brake (left pedal) to decelerate.
Steering: steer the Gokart by slightly turning the steering wheel clockwise or counterclockwise.
⚠ Do not pump the brake pedal to decelerate.

③ Reversing
When the Gokart is stopped, double-press the brake (left pedal). After you hear a beep, the Gokart has switched to reverse mode. Press the throttle to drive the Gokart in reverse. Double-press the brake (left pedal) again to return to forward mode.

④ Emergency braking
In the event of a situation that requires an emergency stop, pull the hand brake handle on the right side of the Gokart to engage the emergency brake.

⚠ Follow the relevant charging instructions in the manual and the common battery maintenance and safety knowledge for maintenance. Ninebot products are designed with overheat protection. If the vehicle temperature exceeds 104 °F (40°C), the vehicle cannot be charged as normal. Wait until the vehicle cools to below 104 °F (40°C) before charging.

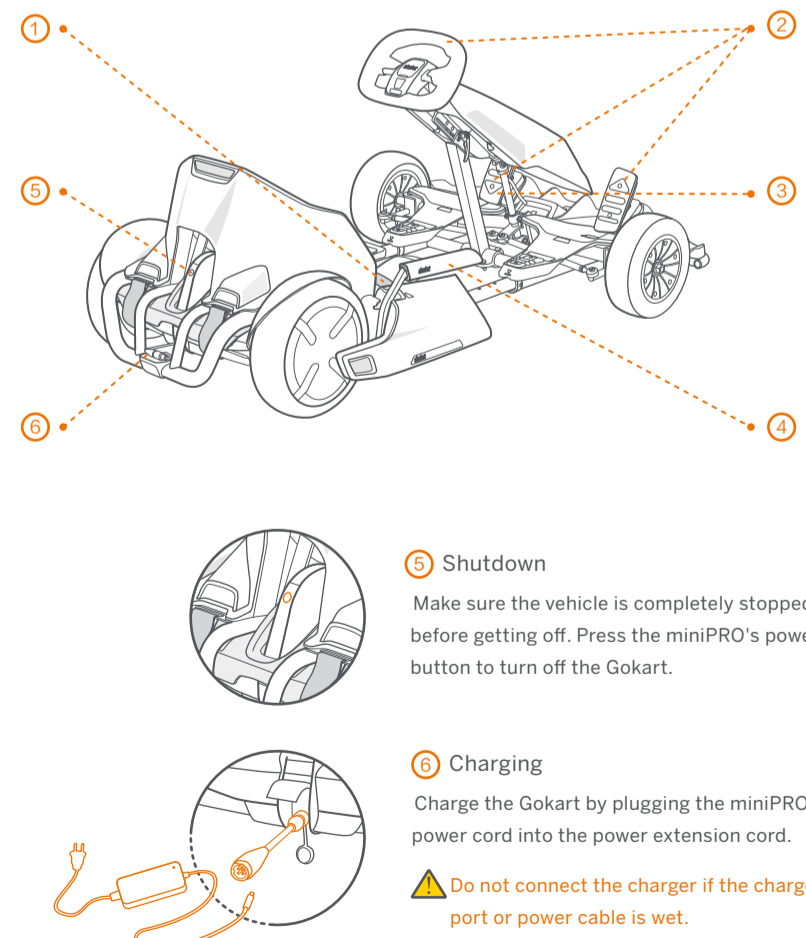

⑤ Shutdown
Make sure the vehicle is completely stopped before getting off. Press the miniPRO's power button to turn off the Gokart.

⑥ Charging
Charge the Gokart by plugging the miniPRO power cord into the power extension cord.
⚠ Do not connect the charger if the charge port or power cable is wet.

6 Specifications

Product	Name	Ninebot Gokart Kit
	Model	N4MZ98
Supported models	Name and model	Ninebot by Segway miniPRO (Model: N3M260, N3M320)
Size	Vehicle size	After extension (Max status): 54×32×24 in (1383×822×600 mm); before extension (Min status): 40×32×18 in (1004×822×459 mm)
	Package size	43.1×34.1×20.1 in (1095×865×510 mm)
Weight	Max payload	220 lbs (100 kg)
	Net weight	61.3 lbs (27.8 kg)
Driving	Height requirement	51-75 in (130-190 cm)
	Recommended Age	8+ years old
Machine Parameters	Speed limit	15 mph (24 km/h)
	Novice speed limit	5 mph (8 km/h)
	Reversing speed limit	2 mph (3 km/h)
	Typical Range ^[1]	9 mile (15km)
	Steering ratio	2.1:1
	Ground clearance	1.6 in (40 mm)
	Maximum slope ^[2]	15°
Front compartment battery ^[3]	Model/Quantity	6 AA Batteries
	Traversable Terrain	Hardened road, flat road surface, slopes below 15°
Tires	Front tires	Tire width: 3 in (80 mm); flatness ratio: 60%; hub diameter: 5 in (127 mm)
	Type	Non-inflatable hollow tire
Light	Headlight	0.2 Watt white LED light bar
	Status indicator	The indicator comes in three colors: blue, yellow, and red. Blue means that the vehicle is in normal condition. Yellow means that the vehicle needs to be activated or the batteries in the front compartment need to be replaced. Red means that the vehicle has a performance failure, and you need to open the app to check the cause of the failure and contact the after-sales service.
Brake	Braking method	Electronic brake + mechanical handbrake
	Braking distance ^[4]	20 ft (6 m)

[1] Typical Range : Under the circumstances of full power, 154 lbs (70kg) load, and 77°F(25°C) ambient temperature, and measured on a flat road at an average speed of 9 mph (15 km/h).

[2] Maximum slope: Refers to the maximum slope that a 220 lbs (100 kg) driver can climb at a speed not faster than 3 mph (5 km/h).

[3] Front compartment battery: The battery compartment inside the frame that is used to power the frame indicator/headlight. When the battery is low, the blue indicator light turns yellow and blinks. You need to replace the batteries yourself.

[4] Braking distance: Under the circumstances of full power, 154 lbs (70kg) load, and measured on a flat hard road at an average speed of 12.4 mph (20 km/h).

Note: You can also open the App for more specific tips.

7 Certification



This device complies with part 15 of the FCC rules. Operation is subject to the following two conditions: (1) This device may not cause harmful interference, and (2) this device must accept any interference received, including interference that may cause undesired operation.

NOTE

This equipment has been tested and found to comply with the limits for a Class B digital device, pursuant to part 15 of the FCC Rules. These limits are designed to provide reasonable protection against harmful interference in a residential installation. This equipment generates, uses and can radiate radio frequency energy and, if not installed and used in accordance with the instructions, may cause harmful interference to radio communications. However, there is no guarantee that interference will not occur in a particular installation. If this equipment does cause harmful interference to radio or television reception, which can be determined by turning the equipment off and on, the user is encouraged to try to correct the interference by one or more of the following measures:

- Reorient or relocate the receiving antenna.
- Increase the separation between the equipment and receiver.
- Connect the equipment into an outlet on a circuit different from that to which the receiver is connected.
- Consult the dealer or an experienced radio/TV technician for help.

This equipment complies with FCC radiation exposure limits set forth for an uncontrolled environment.

Industry Canada (IC) Compliance Statement for Canada

This device complies with Industry Canada license-exempt RSS standard (s). Operation is subject to

the following two conditions: (1) this device may not cause interference, and (2) this device must accept any interference, including interference that may cause undesired operation of the device.

CAN ICES-3 (B)/NMB-3(B)

Neither Segway Inc. nor Ninebot is responsible for any changes or modifications not expressly approved by Segway Inc. or Ninebot. Such modifications could void the user's authority to operate the equipment.

Ninebot Gokart Kit(N4MZ98)

FCC ID:2ALS8-GK7053

IC: 22636-GK7053

8

Trademark and Legal Statement



Ninebot is registered trademark of Ninebot (Tianjin) Tech. Co., Ltd; Ninebot miniPRO, miniPLUS, and miniLITE are trademarks of Ninebot (Tianjin) Tech. Co., Ltd; Segway is registered trademark of Segway Inc; Apple and Apple Logo are registered trademark of Apple Inc in the United States and elsewhere. App Store is service mark of Apple Inc; Android is trademark of Google Inc. Android robots was originally created by Google Inc; The respective owners reserve the rights of their trademarks referred to in this manual.

The Ninebot Gokart Kit is covered by relevant patents. For patent information go to <http://www.segway.com>.

We have attempted to include descriptions and instructions for all the functions of the Gokart Kit at the time of printing. However, your Gokart Kit may differ slightly from the one shown in this document. Please note that there are multiple Ninebot models with different functions, and some of the functions mentioned herein may not be applicable to your unit. The manufacturer reserves the right to change the design and functionality of the Gokart Kit product and documentation without prior notice.

© 2018 Ninebot (Beijing) Tech Co., Ltd. All rights reserved.

9

Contact



Contact us if you experience issues relating to riding, maintenance and safety, or errors/faults with your Gokart Kit.

Segway Inc.

14 Technology Drive, Bedford, NH 03110, USA

Tel : 1-603-222-6000

Fax: 1-603-222-6001

Toll Free: 1-866-473-4929

E-mail Sales: customeroperation@segway.com

E-mail Service: technicalsupport@segway.com

Website: www.segway.com

Have your Gokart Kit's serial number on hand when contacting Segway.

You can find your serial number on the exterior of the shipping box, on the Product or in the Segway-Ninebot App, while connected to the Product.