



KOGAN SMARTERHOME™ ELECTRIC FIREPLACE HEATER

(1800W)

KASHFH18WGA

Safety & Warnings	3
Components	5
Assembly	5
Overview	7
Connect to SmarterHome™ App	8
Operation	13
Specifications	16
Notes	17

SAFETY & WARNINGS

When using this appliance, basic precautions should be followed to reduce the risk of fire, electric shock and injury to person, including the following:

- Read all instructions before installing and operating this appliance. Retain this user guide for future reference.
- This heater must be used on an AC supply only and the voltage marked on the heater must correspond to the supply voltage.
- Do not switch the appliance on until it is properly installed as described in this user guide.
- The heater must not be located directly below an electrical outlet.
- Do not leave the appliance switched on when leaving your home or going to sleep.
- Do not leave unattended when plug in to the mains supply.
- This heater is not intended for use by children. Never leave unsupervised children where the heater is left switched ON (I) or unguarded.
- Only use the appliance for domestic purposes and in the way indicated in these instructions.
- Regularly inspect the power cord for signs of damage. If the power cord is damaged, cease use immediately and contact help.Kogan.com for support.
-  Warning: To avoid overheating, do not cover or obstruct the heater in any way.
- Do not use this heater in the immediate surroundings of a bath, a shower, or a swimming pool.
- Ensure the power cord is kept away from any sources of heat.
- Keep the appliance at least 100cm from walls and any other combustible materials.
- Do not use the appliance outdoors.
- Do not use this appliance with wet hands.
- Never move the appliance by pulling the cord.
- Before cleaning the appliance, ensure it is unplugged from the power and that it is completely cool.
- Do not clean the appliance with abrasive or harsh chemicals.
- Do not use any accessories that are not supplied by Kogan.com.
- Never route the mains cable beneath carpet.
- Do not use aerosols near the heater.
- Never use the heater to dry clothes or other similar items.

- To avoid a hazard due to inadvertent resetting of the thermal cut cut-out, this appliance must not be used with an external switching device, such as a timer or connected to a circuit that is regularly switched on and off by utility.
- This heater must not be used with an extension lead.
- Do not use this heater with a programmer, timer or any other device that switches the heater on automatically, since a fire risk exists if the heater is covered or positioned incorrectly.
- Children should be supervised to ensure that they do not play with the appliance.
- This appliance can be used by children aged from 8 years and above and persons with reduced physical, sensory or mental capabilities or lack of experience or knowledge if they have been given supervision or instruction concerning use of the appliance in a safe way and understand the hazards involved.
- Cleaning and user maintenance shall not be made by children without supervision.
- Children of less than 3 years should be kept away unless continuously supervised.
- Children aged from 3 years and less than 8 years shall only switch on/off the appliance if it has been placed or installed in its intended normal operating position and they have been given supervision or instruction concerning use of the appliance in a safe way and understand the hazards involved. Children aged from 3 years and less than 8 years shall not plug in, regulate and clean the appliance or perform user maintenance.
- Warning: This heater is not equipped with a device to control the room temperature. Do not use this heater in small rooms when they are occupied by persons not capable of leaving the room on their own, unless constant supervision is provided.
- Caution- Some parts of this product can become very hot and cause burns. Particular attention must be given where children and vulnerable people are present.
- This heater (where used with the stand) must be placed on a hard, level, heat resistant surface or attached to a wall.
- Please retain all packaging until you have checked and counted all the parts and the contents of the fixing pack against the component list.
- The fixing pack contains small items which should be kept away from young children.
- Never cover the heater or obstruct the opening at the base of the heater, this could cause overheating and consequently risk of fire.

Safety Cut-out

This heater is fitted with a safety cut-out which will operate if the heater overheats (e.g. Due to blocked air vents). For safety reasons, the heater will not automatically reset. To reset the heater, disconnect the heater from the mains supply for at least 15 minutes. Reconnect the supply to the mains and switch on the heater.

COMPONENTS

- Heater
- Feet x4
- Screws x12
- Remote control
- User guide

ASSEMBLY

Attaching the Feet

1. Ensure that the heater is not plugged in and is completely cool before attaching the feet.
2. Carefully turn the heater over so that the underside is facing upwards. Place it on a soft surface to not scratch the top.
3. Place one of the heater feet against a corner of the underside of the heater, ensuring that the screw holes are aligned with the thread in the heater.
4. Secure the foot to the heater using 3 screws. Tighten them evenly to avoid the foot becoming skewed.
5. Repeat steps 3-4 for each of the 3 remaining feet, until all 4 are securely attached.
6. Carefully turn the heater upright and check the stability of the feet. If there is no excessive wobble once turned upright, then the heater can be placed in the desired position and used normally. If there is wobble, then ensure that the screws are evenly tightened.

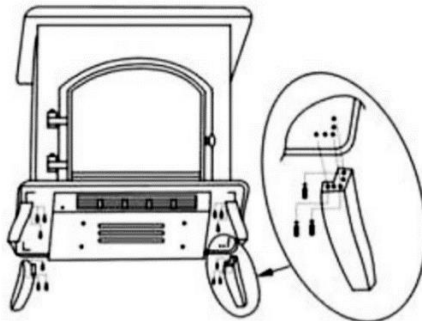

Placement

This heater is designed to be placed on a hard, level surface. When positioning, keep the following in mind:

- If you are placing the heater in an alcove, ensure that there is at least 150mm of space on all sides to ensure proper air circulation.
- The heater must not be located over a fixed electrical socket. The socket must always be accessible to disconnect the heater from the electrical supply for maintenance.
- Keep hearth rugs and other soft furnishings away from the front of the heater. They could obstruct the free flow of hot air from the fan and damage both soft furnishings and heater.

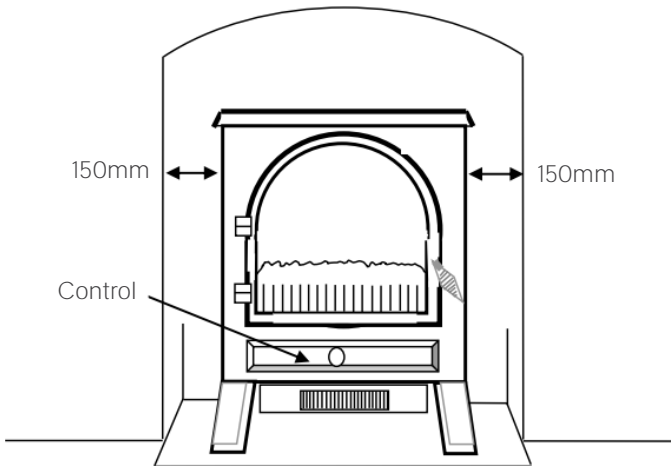

OVERVIEW

Control Panel

The control panel is located under the cover, on the front of the heater.

Note: The master switch must be switched on firstly for all operations.

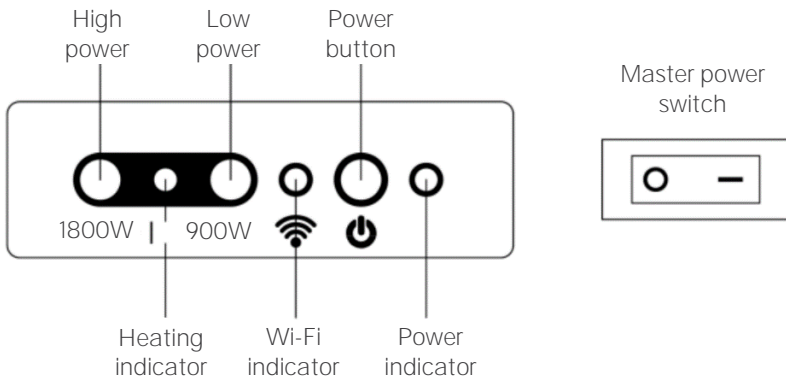

Remote

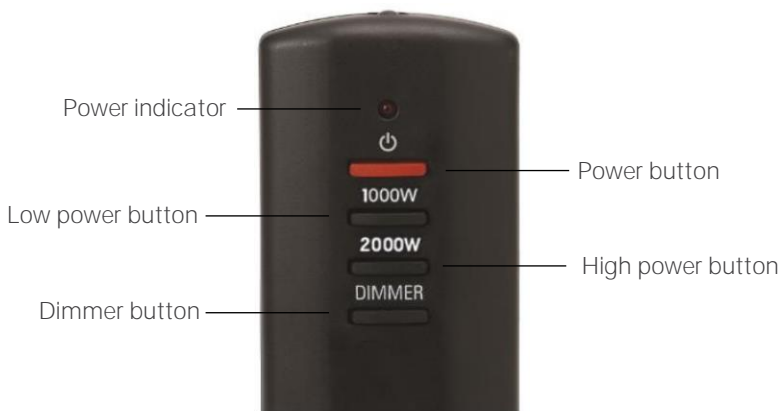

CONNECT TO SMARTERHOME™ APP

Install App

Download the “Kogan SmarterHome” app from the Play Store (Android) or App Store (iOS).



Play Store (Android)



App Store (iOS)



To register:

1. If you already have a SmarterHome account, select ‘Log In’. To register a new account, select ‘Sign Up’.
2. The system will automatically recognise your country. If needed, you can manually select your country from the drop-down box. Enter your email address and tap ‘Get Verification Code’ to continue.
3. A 6-digit code will be sent to the submitted email address. Enter this code before the one-minute timer expires.
4. Continue to the next page and complete your SmarterHome profile.

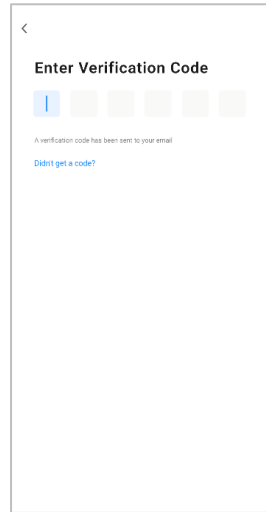
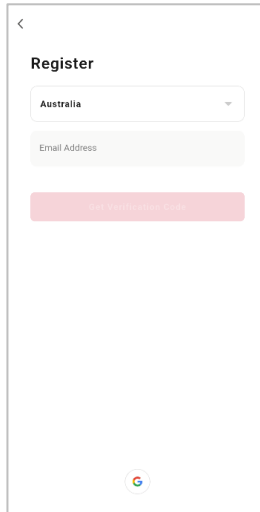

Set device in pairing mode

When the device is first turned on, it may automatically enter pairing mode (Wi-Fi indicator will be flashing rapidly).

If not automatically in pairing mode when powered on, you can manually set the device in pairing mode by turning off the power switch, wait 15 minutes and then turn the power switch back on.

Add device through network

1. Once registered, tap “Add Device” on the app’s home page, or the “+” in the upper right corner, to add a new device through the network.
2. Select the product type from the list of options in the app (Heating & Cooling → Electric Fireplace).
3. Enter your Wi-Fi details. It is important that your SmarterHome™ device and the app are connected to the same Wi-Fi network during setup.

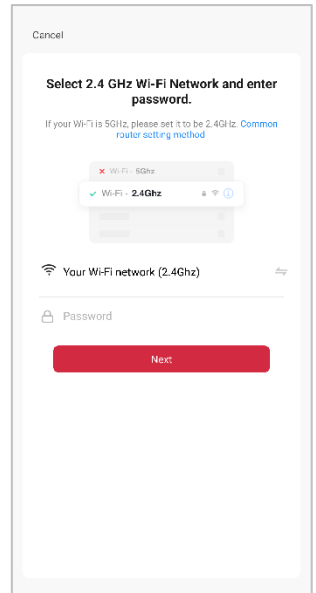
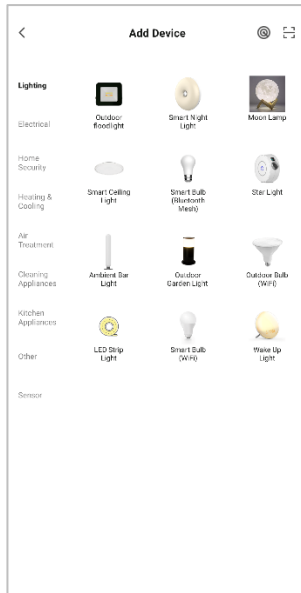
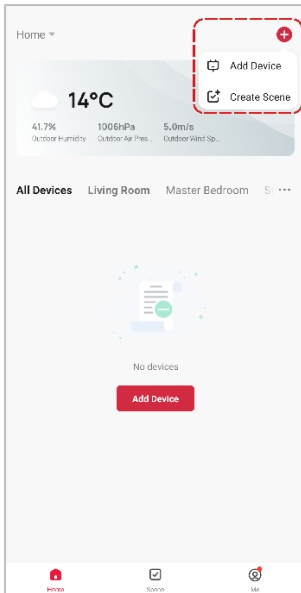

Notes:

- The device and the app have to use the same Wi-Fi network.
- The device is only compatible with 2.4Ghz networks.
- Depending on the product, Steps 3 and 4 may be in opposite order.

4. Ensure that the device is in pairing mode, with the Wi-Fi indicator flashing rapidly, and tap “Confirm light is rapidly flashing”.
5. The device will commence the pairing process and connect to the app. Ensure your Wi-Fi router, mobile phone, and the SmarterHome™ device are kept close until connection is complete.
6. After successfully being added, you will have the option to rename the device and assign it to a location. It will now be listed on the app’s home page. Tap the device listing to enter its control page.

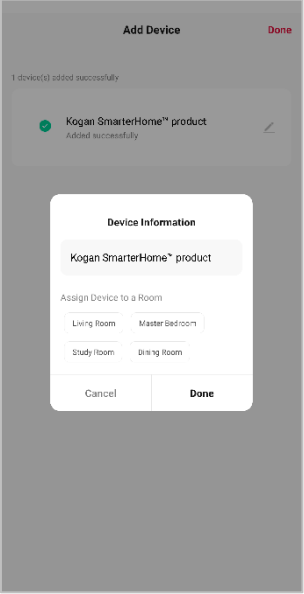
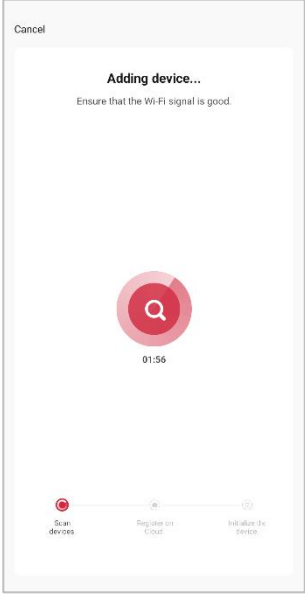
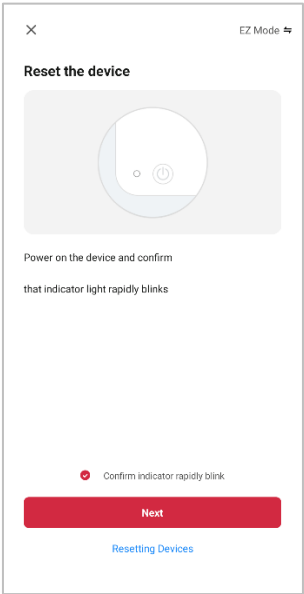

Note:

Once connected, you can select Create Scene from the “+” in the upper right corner (or from the Scene tab) to group connected SmarterHome™ products and automate their functions.

Having trouble connecting?

The prior steps detail the process for “EZ Mode” connection. If that does not work for your connection, we suggest trying it again, and if still no success, attempting the following method for AP Mode connection.

Set device in AP pairing mode

Set the device in pairing mode by turning off the power switch, waiting 15 minutes and then turning the power switch back on. The Wi-Fi indicator should be flashing slowly.

Using AP Mode to add device

1. Follow the previous steps to select your product type (Heating & Cooling → Electric Fireplace).
2. Adjust your connection method by tapping on the mode type in the top-right corner of the screen. Select **“AP Mode”** for the set-up type.
3. Ensure that the device is in pairing mode, with the Wi-Fi indicator flashing slowly. and tap **“Confirm light is slowly flashing”**.

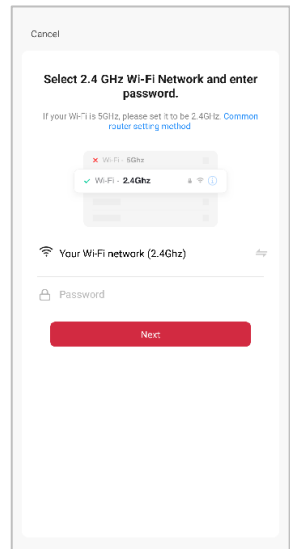
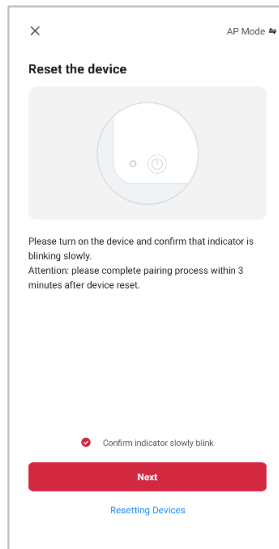
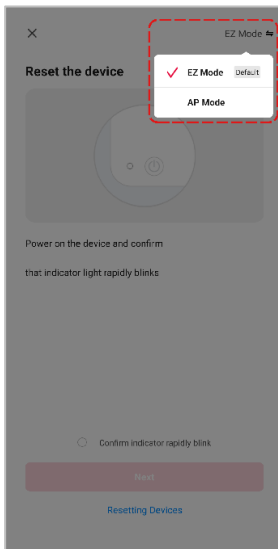

Notes:

- The device and the app have to use the same Wi-Fi network.
- The device is only compatible with 2.4Ghz networks.
- Depending on the product, Steps 3 and 4 may be in opposite order.

4. Enter your Wi-Fi details. It is important that your SmarterHome™ device and the app are connected to the same Wi-Fi network during setup.
5. Follow the in-app prompts to continue AP Mode connection, which will pair your mobile phone to the device's Wi-Fi hotspot to ensure a connection. This may be named "SL-KoganSmart", "SmartLife-XXXX", or another similar name.

Note:

If the Wi-Fi hotspot does not appear on your phone in the list of available networks, your device may not be set in AP Pairing Mode correctly. Try repeating the steps outlined above to ensure your device is ready for connection.

6. The device will commence the pairing process and connect to the app. Ensure your Wi-Fi router, mobile phone, and the SmarterHome™ device are kept close until connection is complete.
7. After successfully being added, you will have the option to rename the device and assign it to a location. It will now be listed on the app's home page. Tap the device listing to enter its control page.

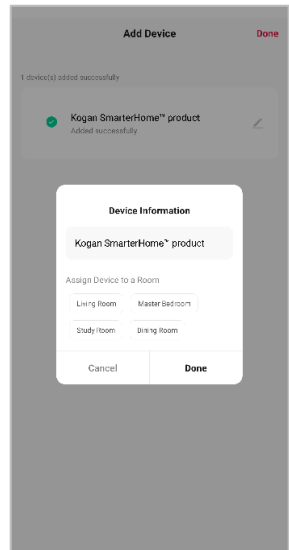
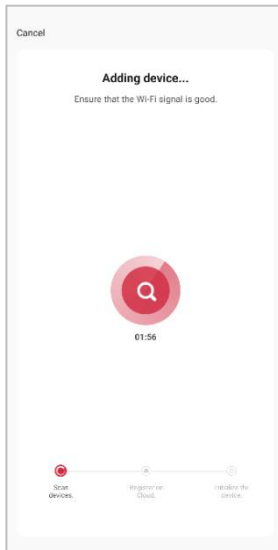
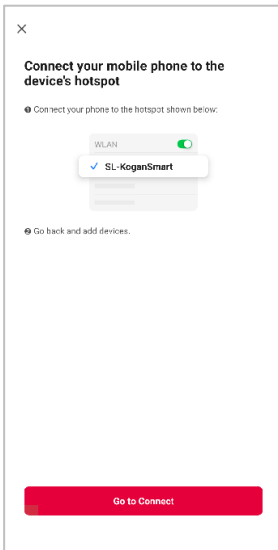

Note:

Once connected, you can select Create Scene from the "+" in the upper right corner (or from the Scene tab) to group connected SmarterHome™ products and automate their functions.

OPERATION

Controls

Once the heater has been connected to the SmarterHome™ App, the smartphone will take control and communicate with the control box. If your home network is not working, it is still possible to operate the heater via the control panel on the heater or with the remote control.

App Interface

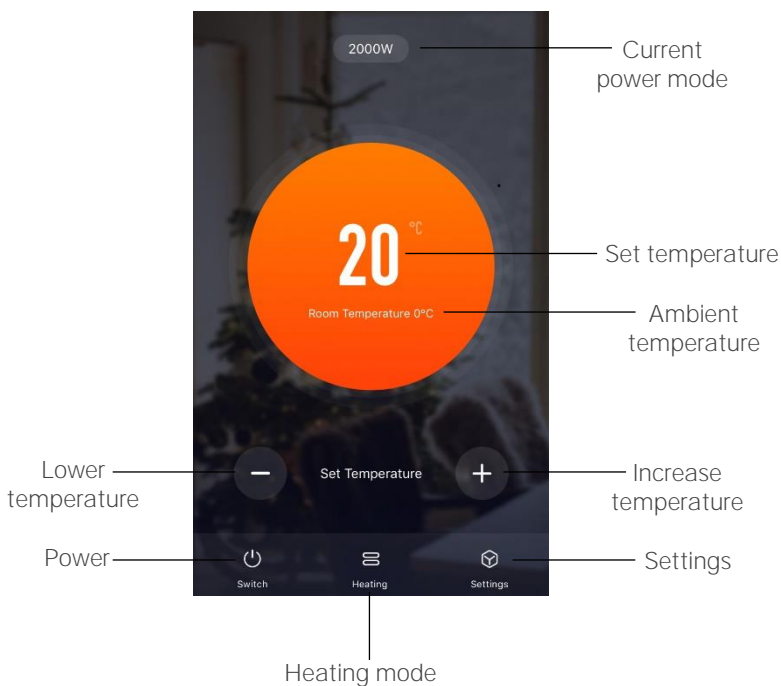

Setting Temperature

This setting is only applicable for the temperature in standard heating mode, not for the temperature in the timer mode. The default set temperature is 30°C.

1. Tap "Switch" to turn the heater and flame effect on.
2. Tap the "+" or "-" buttons to set the desired temperature (range 15 - 30°C).

Changing Power Mode

Tap the “Heating” key to select between 900W (low), 1800W (high) or OFF (No heating). The App and heating indicator will show the heating status.

Heating Indicator	Mode
Green	800W (low)
Red	1800W (high)
Off	Flame effect only

Note:

The heater only starts working when the set temperature is higher than the room temperature.

Setting Flame brightness

Tap “Settings → Brightness” to set the desired flame brightness. The default flame brightness is max level. There are 5 flame brightness levels available.





Setting Timer

1. Tap “Settings → Timer” to set a new timer.
2. Click the “Add” key to set switch-on time firstly, then select switch “ON”, set the desired temperature and set the desired heating level, finally click “Save” to finish the setting of switch-on time.
3. Click “Add Schedule” key to set switch-off time firstly, then select switch “OFF” and click the “Save” to finish the setting of switch-off time.
4. Repeat the “Add Schedule” operations to set more timers.
5. Slide the timer settings leftwards to delete unwanted timers.

Viewing Timer Setting

Tap “Settings → Timer” to view the current timer settings.

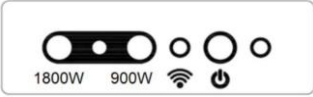
Control Panel Operation

		Turn heater off.
		Turn heater to standby mode.
		<ul style="list-style-type: none">• Press to switch the flame effect on/off.• Press and hold to toggle between 5 different flame brightness levels.
	900W	Press to activate low level heating 900W. The heating pilot light will appear green to indicate that the function is ON.
	1800W	Press to activate high level heating 1800W. The heating pilot light will appear red to indicate that the function is ON.

Optional Remote-control operation

Notes:

- The heater should be powered on using the master switch before it can be operated by remote control.
- The heater only starts working if the set temperature is higher than the room temperature.
- The remote control requires 2x AAA size batteries (Not included).
- There might be a slight delay for the receiver to respond to the transmitter. Do not press the buttons more than once within 2 seconds for the correct operation.

1. Press the  button once on the remote control, this turns the heater and the flame effect ON/OFF.
2. Press the 900W button once for the low heat settings; press twice to switch off the heat setting.
3. The heating pilot light will appear green to indicate that the function is ON.
4. Press the 1800W button once for the high heat settings; press twice to switch off the heat setting.
5. The heating pilot light will appear red to indicate that the function is ON.
6. Press the DIMMER button to toggle between 5 different flame brightness levels.

SPECIFICATIONS

Supply	220-240V~ 50Hz
Rated power	1800W
Lighting	LEDs

NOTES

Need more information?

We hope that this user guide has given you the assistance needed for a simple set-up.

For the most up-to-date guide for your product, as well as any additional assistance you may require, head online to **help.kogan.com**

kogan.com